

SERVICE MANUAL

FISHER

FM-2400

STEREO TUNER

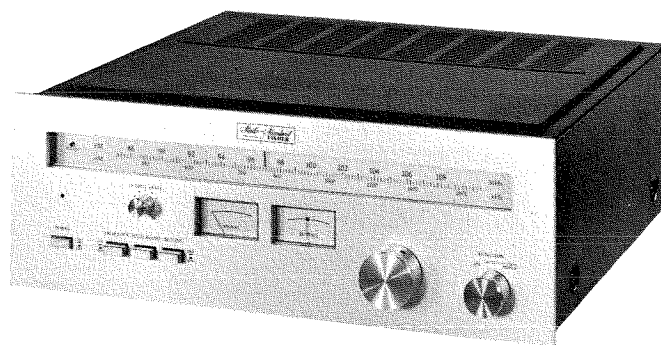

WORLD LEADER IN HIGH QUALITY STEREO

SPECIFICATIONS

FM SECTION

Frequency Range:	Nominal 88 — 108 MHz
Usable Sensitivity:	
Mono:	1.8 μ V
Stereo:	50 μ V
50dB Quieting Sensitivity:	
Mono:	3 μ V
Stereo:	50 μ V
Signal/Hum + Noise (1mV at Ant.):	
Mono:	73dB
Stereo:	65dB
Signal/Hum + Residuals (1mV at Ant.):	
Mono:	73dB
Stereo:	65dB
THD (1mV at Ant.):	
Mono:	0.1%
Stereo:	0.2%
AM Suppression (30% 400 Hz AM):	60dB
Spurious Response (fe + 1/2 FIF):	100dB
Alternate Channel Selectivity:	70dB
Image Response:	90dB
IF Rejection (Unbalanced):	95dB
Capture Ratio:	1dB
Stereo Separation at:	
100 Hz:	40dB
1000 Hz:	50dB
10000 Hz (Hi-Blend Off/On):	40dB
19 kHz Suppression:	70dB
38 kHz Suppression:	70dB
SCA Suppression:	75dB
Spurious MPX Triggering:	
9.5 kHz pilot carrier:	250 kHz
4.75 kHz pilot carrier:	250 kHz
2.375 kHz pilot carrier:	250 kHz
Deviation Sensitivity for Rated Output (500mV):	\pm 75 kHz
Minimum Deviation Required to Trigger Stereo Beacon:	\pm 4.5 kHz
Stereo Trigger Sensitivity:	1.5 μ V
Muting Threshold:	25 μ V
Audio Frequency Response Deviation from STD Deemphasis 50 Hz — 15 kHz:	
Mono:	\pm 1.5dB
Stereo:	\pm 1.5dB

Stereo Channel Balance:	\pm 1.5dB
Sensitivity for Tuning Meter Indication of Pointer Deviation 25%:	25 μ V
Center of Channel Meter Deflection for \pm 100 kHz Detuning:	\pm 5mm
Dial Calibration Error:	\pm 200 kHz
Oscillator Drift, Warmup and \pm 10% Line Voltage Change (88 — 108 MHz):	\pm 30 kHz
Maximum Antenna Signal for 0.5% THD:	4V

AM SECTION

Frequency Range:	535 — 1605 kHz
IHF Usable Sensitivity (20dB):	
600 kHz:	300 μ V/m
1000 kHz:	300 μ V/m
1400 kHz:	300 μ V/m
Signal to Noise and Hum Ratio at 100mV/m:	55dB
Image Response:	70dB
IF Rejection:	90dB
Selectivity \pm 10 kHz:	40dB
Spurious Response 455 kHz to 30 MHz (Limit):	80dB
Sensitivity for Tuning Meter Reading of 25% Pointer Deviation:	600 μ V/m
Rated Output Mod. 80% 100mV/m Ant.:	Fixed 500mV \pm 2dB Regulated 1.3V \pm 2dB 500 μ V/m
Volume Sensitivity:	
Modulation for Rated Output (100mV/m) Antenna Signal:	25%
THD 30% AM (100mV/m) Antenna Signal:	0.2%
THD 80% AM (100mV/m) Antenna Signal:	0.3%
Overall Audio Frequency Response ($-$ 3dB):	2.2 kHz
Dial Calibration Error:	600KHz \pm 10KHz 1,000KHz \pm 20KHz 1,400KHz \pm 10KHz
Oscillator Drift, Warm-up and \pm 10% Line Voltage Change (550 — 1600 kHz):	\pm 1 kHz
Maximum Antenna Signal for 3% THD:	2V

DIAL CORD STRINGING

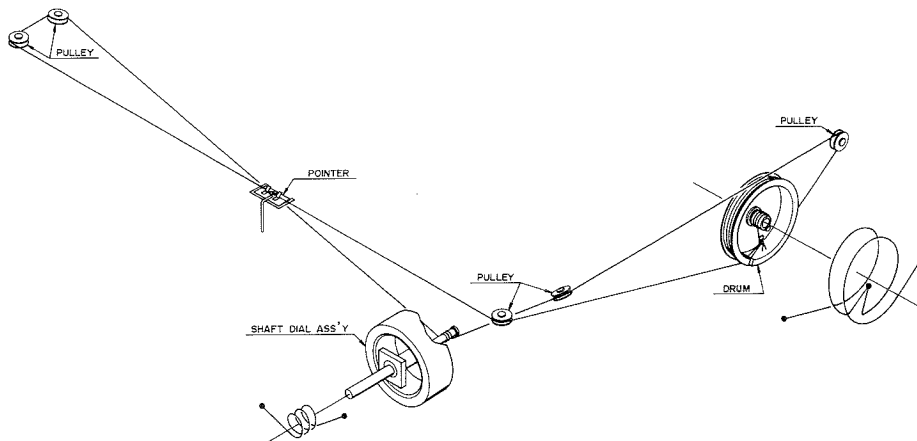

FRONT END ADJUST POINTS

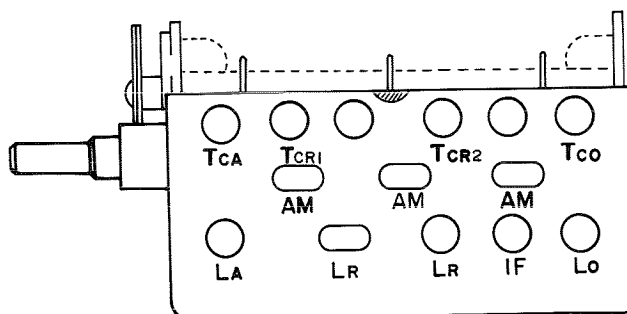

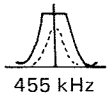

AM-FM-MPX ALIGNMENT PROCEDURE

AM ADJUSTMENT

Step	Adjusting circuit	Connections		SG. frequency	Position of tuning dial	Adjustment	V.T.V.M. Oscilloscope
		Input	Output				
1	IF	Connect sweep generator to VC AM.	Connect oscilloscope to test point TP1	455 kHz	Near max. capacity of VC. at position with no signal.	AM 1st 9-21200	 455 kHz
2	RF	Connect standard loop aerial to output terminals of SG. Place receiver 2 feet from loop aerial.	Connect V.T.V.M. to TP-2	600 kHz (400 Hz, 30% modulation)	600 kHz	AM AERIAL 9-20420 AM OSC 9-20740	Max.
3				1400 kHz (400 Hz, 30% modulation)	1400 kHz	TC4 TC5	Max.
4	Repeat adjustments.						

1. Variable capacitor completely closed.
2. Set the dial pointer to very left line dial scale.
3. Connect sweep generator, SG, V.T.V.M. and oscilloscope.
4. Function switch to "AM".
5. Use a screwdriver with plastic grip for all adjustments.

FM ADJUSTMENT

Step	Adjusting circuit	Connections		SG. frequency	Position of tuning dial	Adjustment	V.T.V.M. Oscilloscope
		Input	Output				
1	IF		Connect oscilloscope to test point TP-3 of IC, 03 (LA1222)			IF IN Front End (IF)	 10.7 MHz
2	Ratio Det.	Connect sweep generator to test point front End TP-4 through 0.01MF	Connect distortion meter to test point Fixed, OUT (Distortion, MIN)	10.7 MHz (none modulation)	Near max. capacity of VC. at position with no signal.	FM DET 9-20260 9-20270 Indicator Point to the center of scale FM Tuning Meter	 10.7 MHz
3	RF	Connect FM SG. to FM aerial terminals.	Connect V.T.V.M. to Fixed OUT.	90 MHz (400 Hz, 30% modulation)	90 MHz	LA, LR1, LR2, LO, TCO, TCA, TCR1, TCR2	Max.
4				106 MHz (400 Hz, 30% modulation)	106 MHz		Max.
5	Repeat adjustments.						

1. Variable capacitor completely closed.
2. Set the dial pointer to very left line of dial scale.
3. Connect sweep generator, FM SG, V.T.V.M. and oscilloscope.
FM aerial input impedance is 300 ohm.
4. Function switch to "FM MONO".
5. Use a screwdriver with plastic grip for all adjustments.

FM MPX ADJUSTMENT

Step	Adjusting circuit	Connections		Position of tuning dial	Adjustment	
		Input	Output			
1	PLL IC FO (19 kHz) Adjustment	None	Connect Frequency counter or syncroscope to TP5 of IC, 06 (LA3350-B)		Adjust VR, 01 (4.7K-B) so that 19 kHz may be indicated on the frequency counter or syncroscope.	
2	FM stereo Signal Separation	Connect FM stereo SG. to FM aerial terminals. 19 kHz signal ON. Main channel, sub channel signal ON. Add 1000 Hz Signal from L Ch.	Connect V.T.V.M. to output terminal (R channel).	Near max. capacity of VC. at position with no signal.	VR (1.5K-B)	V.T.V.M. Min.
		Connect FM stereo SG to FM aerial terminals. 19 kHz signal ON. Main channel, sub channel signal ON. Add 1000 Hz signal from R Ch.	Connect V.T.V.M. to output terminal (L channel).			
3	Repeat steps 1 – 2. Set at position with max. channel separation.					

1. Variable capacitor completely closed.
2. Connect FM stereo SG. and V.T.V.M.
3. Function switch to "FM AUTO".
4. Use a screwdriver with plastic grip for all adjustments.

EXPLODED VIEW

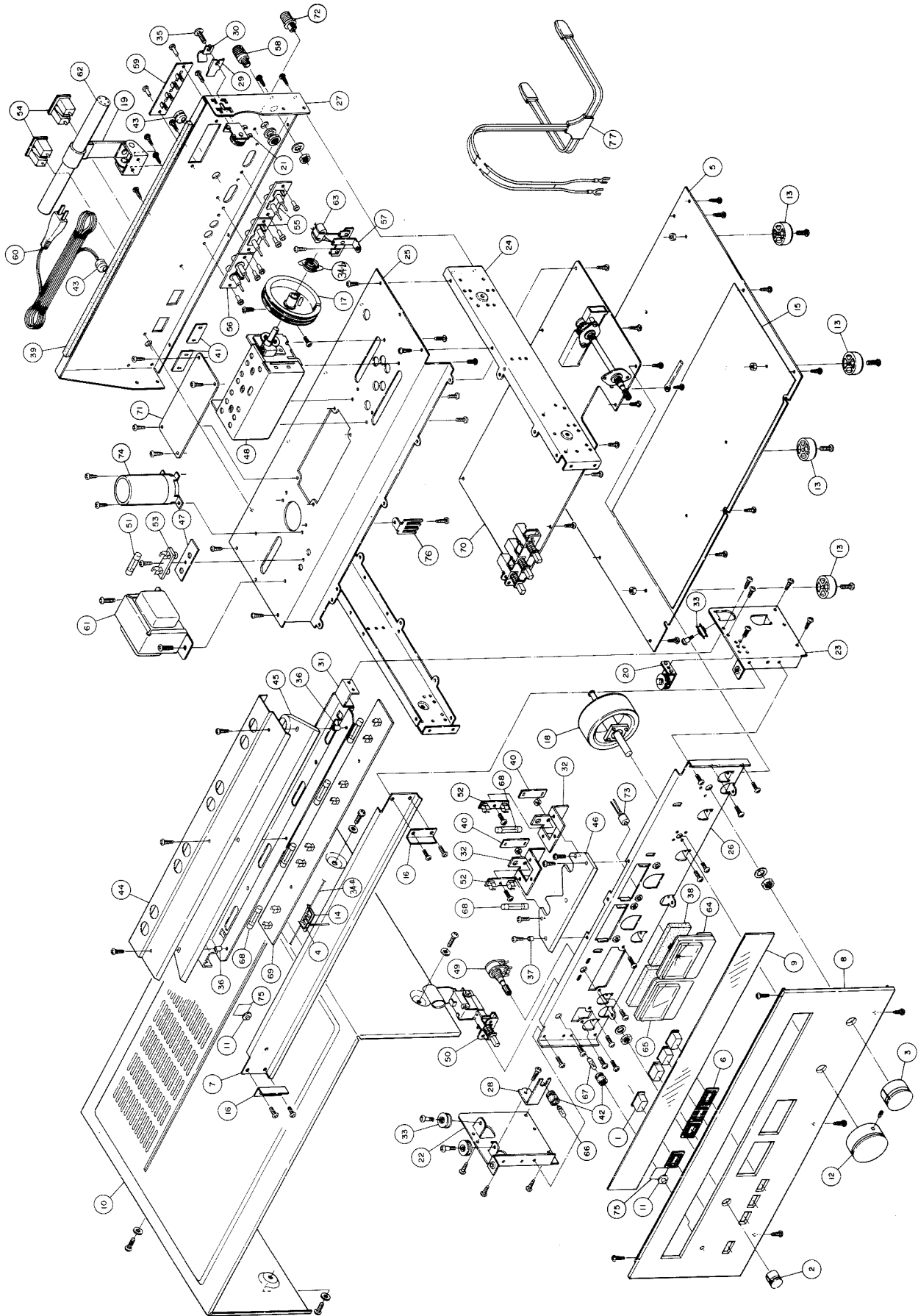

PARTS LIST

Ref. No.	Part No.	Description
CHASSIS MECHANICAL PARTS		
1	EK1310100132200	Knob Assembly, Push Switch
2	EK1310100133400	Knob Assembly, Output Level
3	EK1310100133600	Knob Assembly, Function
4	1310301115800	Pointer Assembly
5	1312110515601	Bottom Cover
6,8,9,11,75	1310101621400	Dress Panel Assembly
7-1	1312120127502	Dial Scale
10	1312140113901	Top Cover
12	EK1312160137800	Knob, Tuning
13	EA1312180113300	Leg
17	1310300211100	Drum Assembly, Tuning Gang
18	1310300317900	Tuning Shaft Assembly
19	1310300811700	Antenna Mounting Bracket
CHASSIS ELECTRICAL PARTS		
48	FE4125920341	Front End
49	RV4222925090	Variable Resistor, 10K Output Level
50	SP4231933750	Switch Power
51	FL51313-4	Fuse 0.5 Amp 250V Slo-Blo
52	4235920160	Fuse Holder, Meter Lamp
53	4235921062	Fuse Holder, Power
54	JK4235921960	AC Outlet
55	JK4235922380	Jack, 2P Output
56	JK4235922450	Jack, 2P, FM Composite Output
59	ET4237921460	Antenna Connecting Terminal
60	WR2740241	Line Cord, AC
61	TD4251923463	Power Transformer
62	LA4257921026	AM Bar Antenna
63	4259920300	Balun
64	MC4511920521	Meter, Tuning
65	MC4511920491	Meter, Signal
66	LM4612920142	Lamp, Stereo Indicator 6V 25mA
67	LM4612920240	Pilot Lamp, Power Indicator 6.3V 80mA
68	LM4612920280	Pilot Lamp, Meter/Dial 6.3V 250mA
73	LM4612920630	Indicator Lamp, Tuning Meter 3V 10mA
74	CE4223920930	Cap. Elect. 2200MF x 2 35V
C02	CK22359-1	Cap. Cer. 0.01MF 500V +100 -0%
C04	CK22354-1	Cap. Cer. 0.01MF 50V +80 -20%
L101	LC4253920150	Choke Coil, AM
69*	PB1310400167100	Lamp PCB Assembly
70*	PB1310400167301	FM IF MPX PCB Assembly
71*	PB1310400167400	AM PCB Assembly

* NOT A SERVICE ITEM

Ref. No.	Part No.	Description
AM PCB BOARD ASSEMBLY		
	LC4253920310	Coil, 1μH 5%
	ZZ4256921200	AM IF Trans.
	LC4258920740	AM Osc. Coil
	LC4259920420	AM RF Coil
C12,22	CE1252521	Cap. Elect. 10MF 16V
C14,19	CE1252515	Cap. Elect. 4.7MF 16V
C13	CE22342-8	Cap. Elect. 47MF 16V
C20	CL22305-7	Cap. Sint. Alum. 0.1MF 16V 20%
C21	CL22305-5	Cap. Sint. Alum. 1MF 16V 20%
C06,11	CK22344-6	Cap. Cer. 12pf 50V 10%
C15	CK22347-5	Cap. Cer. 220pf 50V
C16,17	CY22335-1	Cap. Mylar 0.01MF 50V
C10	CP0228326	Cap. Styro 430pf 50V 5%
C01,02,05,07,09	CK22354-2	Cap. Cer. 0.02MF 50V +80 -20%
C03,04,08,18	CK22348-1	Cap. Cer. 0.05MF 50V +80 -20%
IC01	TRHA1138	IC HA1138
R04,15,20	RF25DC102J	Res. Dep. Carb. 1K ohms 5% 1/4W
R19	RF25DC104J	Res. Dep. Carb. 100K ohms 5% 1/4W
R05	RF25DC151J	Res. Dep. Carb. 150 ohms 5% 1/4W
R10,13,14	RF25DC222J	Res. Dep. Carb. 2.2K ohms 5% 1/4W
R01	RF25DC223J	Res. Dep. Carb. 22K ohms 5% 1/4W
R17	RF25DC273J	Res. Dep. Carb. 27K ohms 5% 1/4W
R03,11	RF25DC332J	Res. Dep. Carb. 3.3K ohms 5% 1/4W
R21,22	RF25DC392J	Res. Dep. Carb. 3.9K ohms 5% 1/4W
R06,07,08,16	RF25DC470J	Res. Dep. Carb. 47 ohms 5% 1/4W
R02	RF25DC472J	Res. Dep. Carb. 4.7K ohms 5% 1/4W
R18	RF25DC473J	Res. Dep. Carb. 47K ohms 5% 1/4W
R23	RF25DC563J	Res. Dep. Carb. 56K ohms 5% 1/4W
R12	RF25DC681J	Res. Dep. Carb. 680 ohms 5% 1/4W
R09	RF25DC683J	Res. Dep. Carb. 68K ohms 5% 1/4W
Q02,03	2SC1570	Transistor 2SC1570
Q01	2SC930E	Transistor 2SC930E
D01,02	TRDS442	Diode, DS442

PARTS LIST

Ref. No.	Part No.	Description
LAMP PCB BOARD ASSEMBLY		
	LM4612920280	Pilot Lamp 6.3V 250mA

DIAL LAMP PCB ASSY BOTTOM VIEW

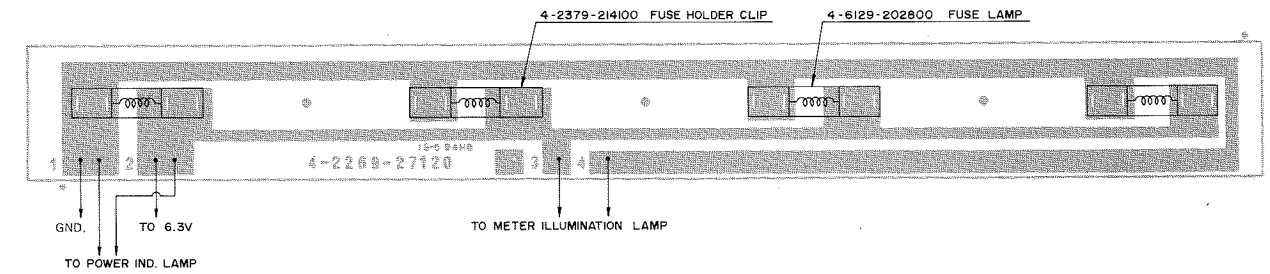

AM PCB ASSY BOTTOM VIEW

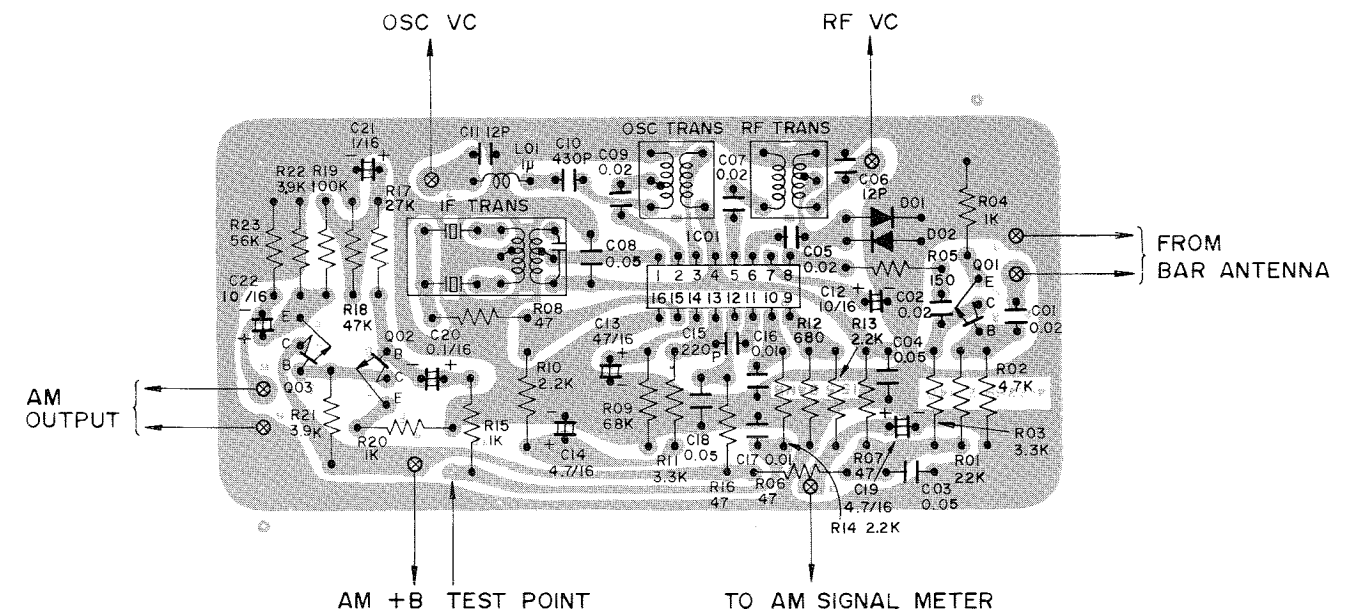

IC01 HA1138
 Q01 2SC930 D or E
 Q02, 03 2SC1570 GL
 D01, 02 DS-442

PARTS LIST

Ref. No.	Part No.	Description	Q'ty
FM IF MPX PC BOARD ASSEMBLY			
VR03,04	RV4222922910	Variable Resistor, 1K Separation	
VR01	RV4222923880	Variable Resistor, 4.7K	
VR02	RV4222925250	Variable Resistor, 1.5K-B	
	4227920230	Low Pass Filter	
	4227920260	Filter, FM IF	
	4 2279 20270	Filter, FM IF	
	SR4231924250	Switch, Function	
	SP4231924270	Switch Push, AFC-Muting-Hi-Blend	
	4232920190	Relay, Freq. Lock	
	4232920200	Relay, FM Muting	
	4234920030	Fuse 2 Amp	
	FL51313-4	Fuse 0.5 Amp 250V Slo-Blo	
L01,02,03, 04,05,06, 07	LC4253920290	Coil, Inductor 100μH	
	ZZ4256921210	Discriminator Transformer	
	ZZ4256921220	Muting Transformer	
C25	CE22342-31	Cap. Elect. 470MF 6.3V	
C23,44	CE0252221	Cap. Elect. 10MF 10V	
51,84			
C60,61	CE1252323	Cap. Elect. 33MF 10V	
C75,76	CE22342-12	Cap. Elect. 100MF 16V	
C77,78	CE0256010	Cap. Elect. 1000MF 16V	
C86	CE22342-8	Cap. Elect. 47MF 16V	
C68,69	CE402470519	Cap. Elect. 470MF 16V	
C43	CE22342-11	Cap. Elect. 100MF 25V	
C42	CE22342-6	Cap. Elect. 22MF 25V	
C73,74	CE22342-14	Cap. Elect. 220MF 25V	
C52,53,56, 57,66,67	CE22342-4	Cap. Elect. 10MF 50V	
C32	CK0248631	Cap. Cer. 1pf 50V ±0.25pf	
C28	CK22345-1	Cap. Cer. 3pf 50V ±0.25pf	
C29,36,37	CK22345-3	Cap. Cer. 10pf 50V ±0.5pf	
C89	C1HCDK360SL	Cap. Cer. 36pf 50V 10%	
C27,54,55, 58,59	CK22347-1	Cap. Cer. 100pf 50V 10%	
C21,22,24, 70,71	CK22347-6	Cap. Cer. 270pf 50V 10%	
C62,63	CY22335-23	Cap. Mylar 1200pf 50V 20%	
C83	CY22335-12	Cap. Mylar 0.022MF 50V 20%	
C49	CY22335-20	Cap. Mylar 0.22MF 50V 20%	
C48,50	C1HFRM354A-	Cap. Mylar 0.33MF 50V	
C46	CY22335-22	Cap. Mylar 0.047MF 50V	
C26,41	CE22342-3	Cap. Elect. 1MF 50V	
C47	CP1274012	Cap. Styro 1500pf 35V 5%	
C64,65	CP1274013	Cap. Styro 2200pf 50V 5%	
C45	CP0221370	Cap. Styro 680pf 50V 10%	
C85	CK22349-1	Cap. Cer. 0.01MF 50V +80 -20%	
C87,88	CK22348-1	Cap. Cer. 0.05MF 50V +80 -20%	
C01,04,06, 08,11,13, 15,18	CK22355-4	Cap. Cer. 1000pf 50V +80 -20%	
C02,03,05, 07,09,10, 12,14,16, 17,19,20, 30,31,33, 34,35,38, 39,40,72	CK22349-3	Cap. Cer. 0.02MF 50V +80 -20%	
C79,80,81, 82	CK22359-1	Cap. Cer. 0.01MF 500V +100 -0%	
D16,17	TRRD6.2E	Diode RD-6.2E	
IC04	TRMPC55A	IC MPC55A	
R14,88	RF25DC101J	Res. Dep. Carb. 100 ohms 5% 1/4W	
R04,07,10, 11,41,65, 66	RF25DC102J	Res. Dep. Carb. 1K ohms 5% 1/4W	
R23,25,37, 38,39,73, 74	RF25DC103J	Res. Dep. Carb. 10K ohms 5% 1/4W	
R42,43,24, 71,72,26	RF25DC104J	Res. Dep. Carb. 100K ohms 5% 1/4W	
R19,21,27, 28	RF25DC105J	Res. Dep. Carb. 1M ohms 5% 1/4W	
R59,60	RF25DC122J	Res. Dep. Carb. 1.2K ohms 5% 1/4W	
R35,55,56	RF25DC123J	Res. Dep. Carb. 12K ohms 5% 1/4W	
R18	RF25DC152J	Res. Dep. Carb. 1.5K ohms 5% 1/4W	
R16,17	RF25DC154J	Res. Dep. Carb. 150K ohms 5% 1/4W	
R36	RF25DC183J	Res. Dep. Carb. 18K ohms 5% 1/4W	
R50,61,62	RF25DC221J	Res. Dep. Carb. 220 ohms 5% 1/4W	

Ref. No.	Part No.	Description
FM IF MPX PC BOARD ASSEMBLY		
R03,06,09, 57,58	RF25DC222J	Res. Dep. Carb. 2.2K ohms 5% 1/4W
R29	RF25DC223J	Res. Dep. Carb. 22K ohms 5% 1/4W
R34	RF25DC273J	Res. Dep. Carb. 27K ohms 5% 1/4W
R30,40,48, 49,51,53, 54,67,68	RF25DC332J	Res. Dep. Carb. 3.3K ohms 5% 1/4W
R69,70	RF25DC333J	Res. Dep. Carb. 33K ohms 5% 1/4W
R22	RF25DC335J	Res. Dep. Carb. 3.3M ohms 5% 1/4W
R31	RF25DC392J	Res. Dep. Carb. 3.9K ohms 5% 1/4W
R20	RF25DC470J	Res. Dep. Carb. 47 ohms 5% 1/4W
R32,79,80	RF25DC471J	Res. Dep. Carb. 470 ohms 5% 1/4W
R83,84	RF25DC472J	Res. Dep. Carb. 4.7K ohms 5% 1/4W
R52	RF25DC473J	Res. Dep. Carb. 47K ohms 5% 1/4W
R15	RF25DC474J	Res. Dep. Carb. 470K ohms 5% 1/4W
R44,45,77, 78,81,82	RF25DC561J	Res. Dep. Carb. 560 ohms 5% 1/4W

FM IF PCB ASSY TOP VIEW

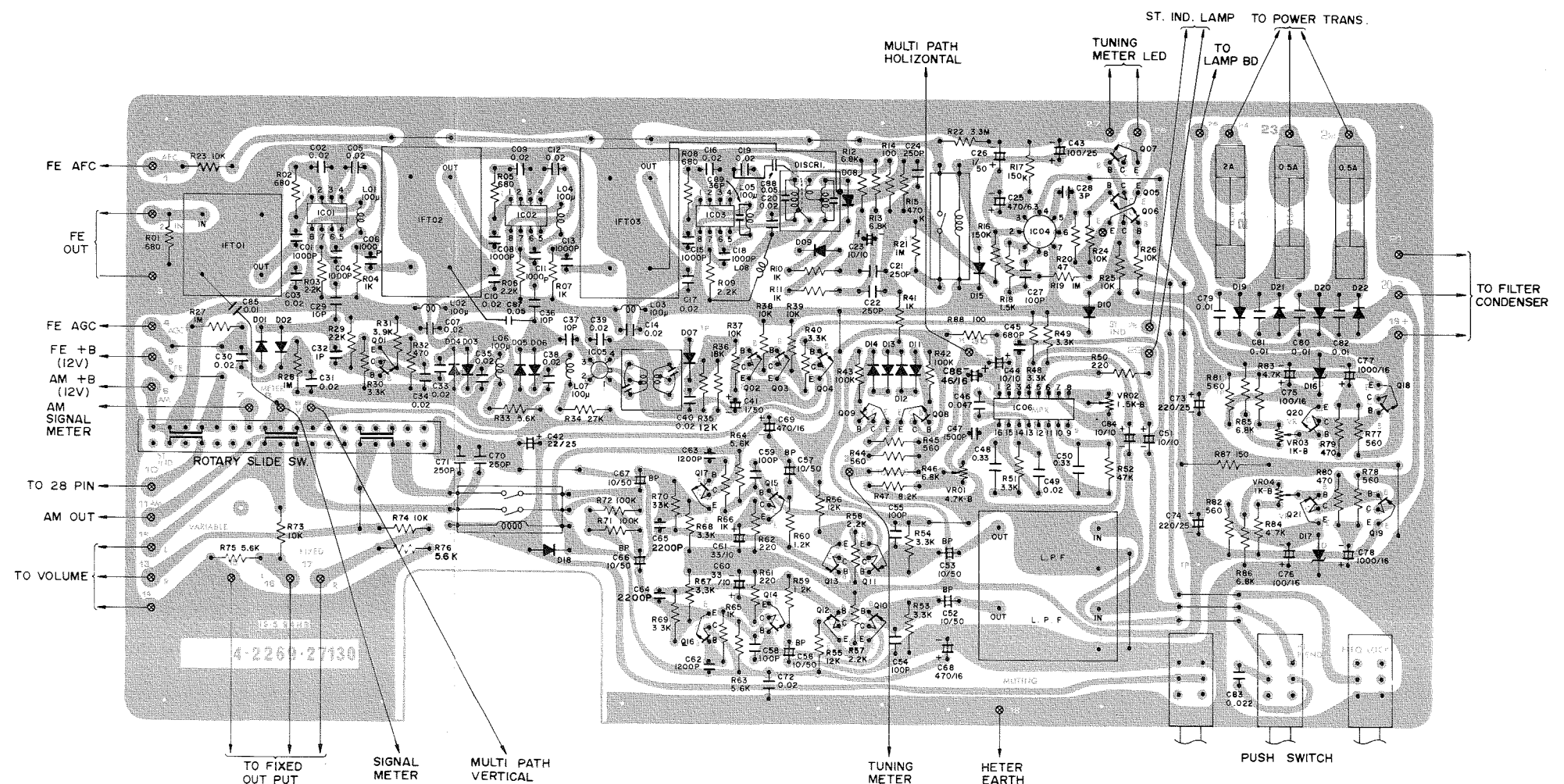

Q01	2SC930	D01 ~ 09	1S188	IC01 ~ 03	LA1222
Q02, 03, 05 ~ 07	2SC536	D10 ~ 15, 18	DS-442	IC04	μPC55A
Q04	2SC1175	D16, 17	RD6.2	IC05	LA1221
Q08, 14 ~ 17, 20	2SC1570	D19 ~ 22	DS-130	IC06	LA3350
Q09 ~ 13, 21	2SA702				
Q18	2SD330				
Q19	2SB514				

PARTS LIST

Ref. No.	Part No.	Description
FM IF MPX PC BOARD ASSEMBLY		
R63,64,75, 76,33	RF25DC562J	Res. Dep. Carb. 5.6K ohms 5% 1/4W
R01,02,05, 08	RF25DC681J	Res. Dep. Carb. 680 ohms 5% 1/4W
R12,13,46, 85,86	RF25DC682J	Res. Dep. Carb. 6.8K ohms 5% 1/4W
R47	RF25DC822J	Res. Dep. Carb. 8.2K ohms 5% 1/4W
R87	RW200W151J	Res. 150 ohms 2W 10%
D19,20,21, 22	TRDS130YD	Diode, DS130YD
D01,02,03, 04,05,06, 07,08,09	TR1S188FM	Diode, 1S188FM1-A
Q02,03,07, 05,06	TR2SC536	Transistor, 2SC536

Ref. No.	Part No.	Description
FM IF MPX PC BOARD ASSEMBLY		
Q08,14,15, 16,17,20	TR2SC1570	Transistor, 2SC1570
Q01	TR2SC930E	Transistor, 2SC930E
Q19	TR2SB514E	Transistor, 2SB514E
Q04	TR2SC1175D	Transistor, 2SC1175D
Q09,10,11, 12,13,21	TR2SA702F	Transistor, 2SA702F
Q18	TR2SD330E	Transistor, 2SD330E
D10,11,12, 13,14,15, 18	TRDS442	Diode DS-442
IC05	TRLA1221	IC, LA1221
IC01,02, 03	TRLA1222	IC, LA1222
IC06	TRLA3350SS	IC, LA-3350SS

WIRING DIAGRAM

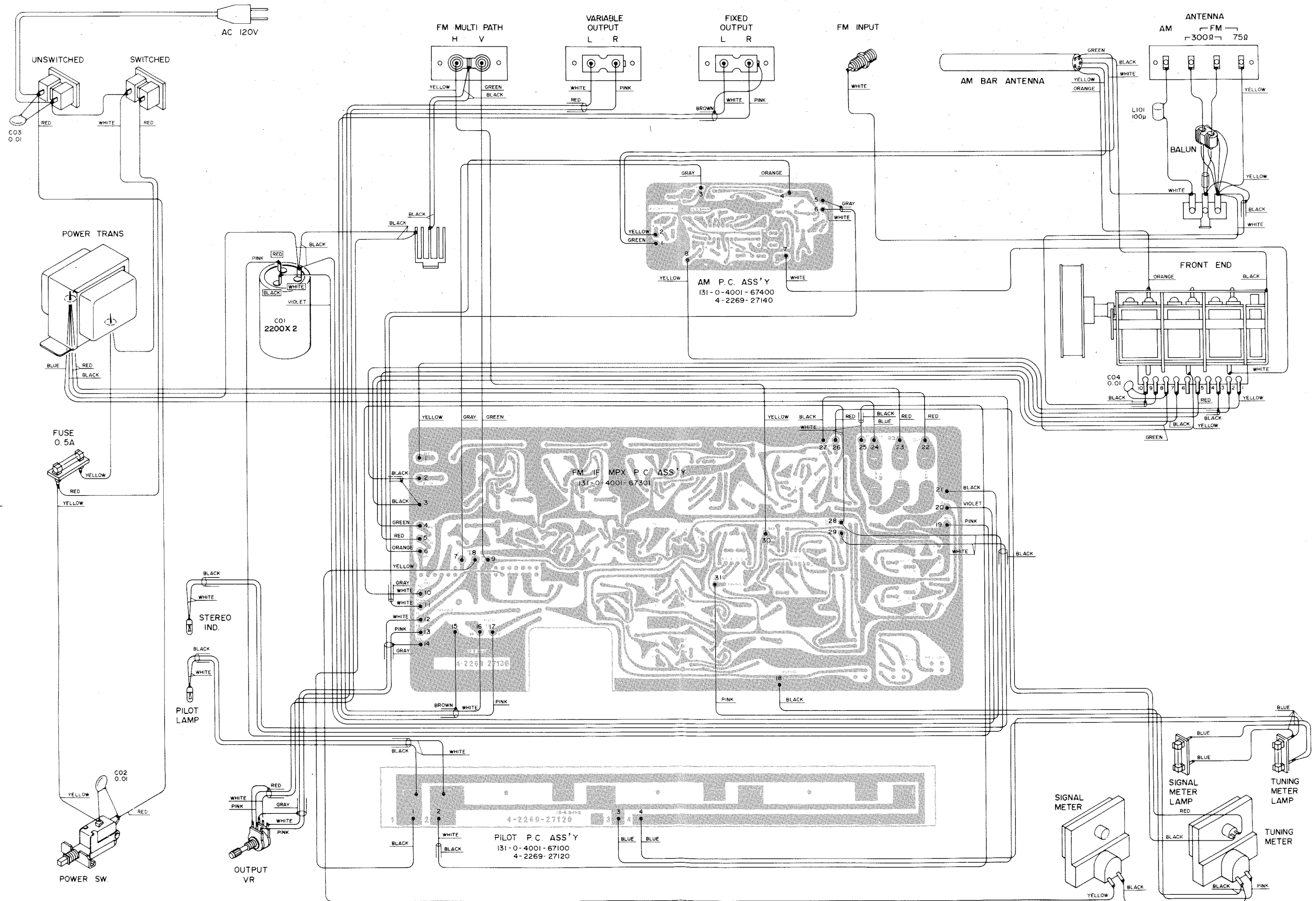

SCHEMATIC DIAGRAM

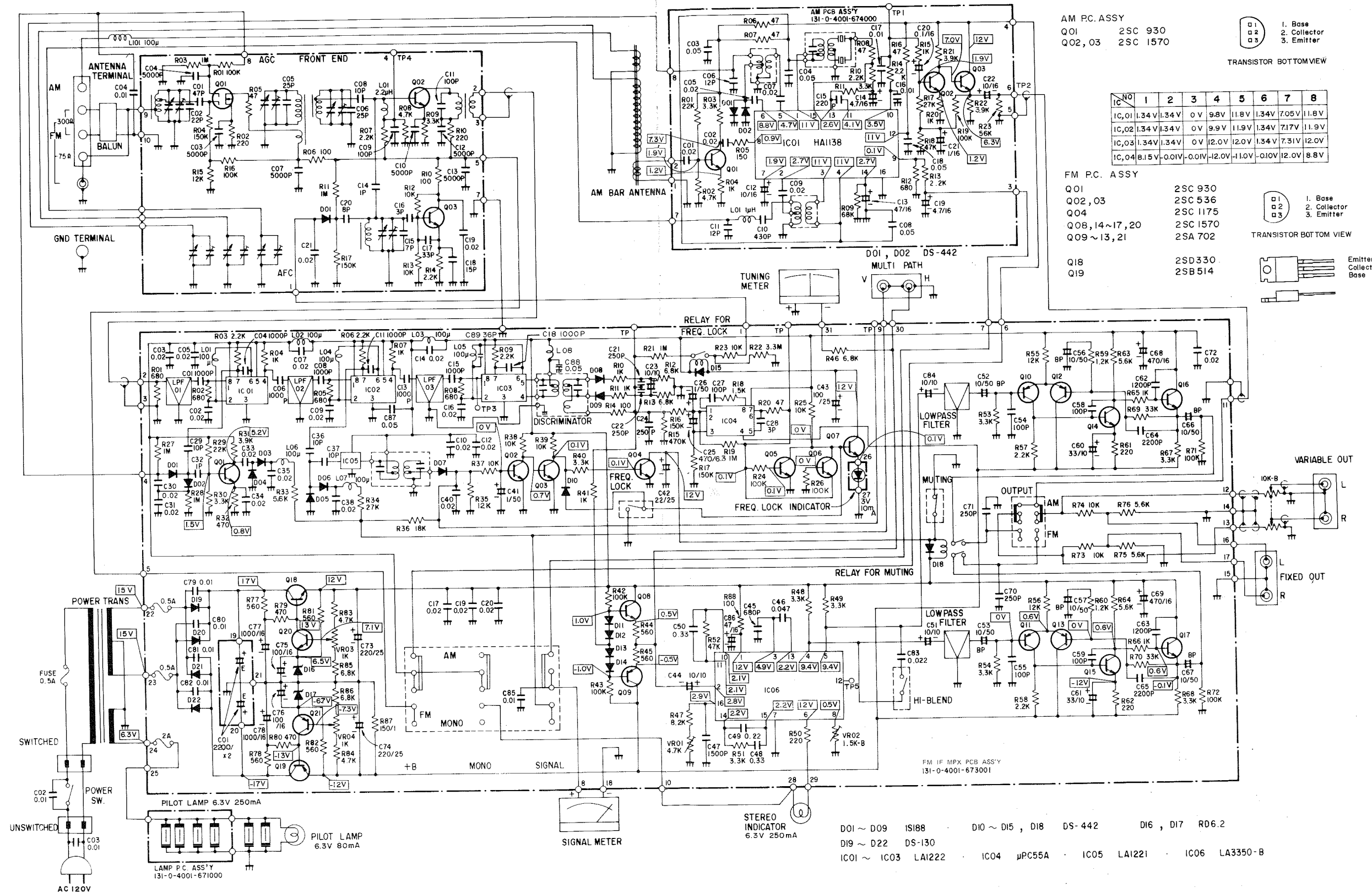

AM PCB ASSY
 Q01 2SC 930
 Q02, 03 2SC 1570

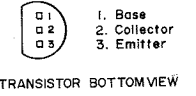

IC No	1	2	3	4	5	6	7	8
IC,01	1.34V	1.34V	0V	9.8V	11.8V	1.34V	7.05V	11.8V
IC,02	1.34V	1.34V	0V	9.9V	11.9V	1.34V	7.17V	11.9V
IC,03	1.34V	1.34V	0V	12.0V	12.0V	1.34V	7.31V	12.0V
IC,04	8.15V	0.01V	0.01V	-12.0V	-1.10V	0.10V	12.0V	8.8V

FM PCB ASSY
 Q01 2SC 930
 Q02, 03 2SC 536
 Q04 2SC 1175
 Q08, 14~17, 20 2SC 1570
 Q09~13, 21 2SA 702
 Q18 2SD330
 Q19 2SB514

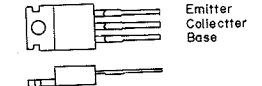
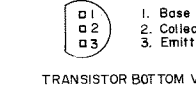

D01 ~ D09 IS188 D10 ~ D15, D18 DS-442 D16, D17 R06.2
 D19 ~ D22 DS-130
 IC01 ~ IC03 LA1222 IC04 μPC55A IC05 LA1221 IC06 LA3350-B



FISHER CORPORATION 11-40 45th ROAD • LONG ISLAND CITY • NEW YORK 11101